

SHENYUN

Suzhou Shenyun Medical Equipment Co., Ltd.

Add: No. 666, Yinzang Road, Linhu Town,, Suzhou City 215104, China

P: + 86 182 2153 2164 | E: Jolin@symedical.com.cn

www.shenyunmedical.com



Jack Liu



@shenyun_medical



@shenyun_medical



Suzhou Shenyun Medical Equipment Co., Ltd.



CONTENTS

ABOUT SHENYUN 4

WEIGHT LOSS PRODUCT SERIES 5

I Type Gastric calibration tube 6
II Type Gastric calibration tube 7
Gastric balloon 8
Silicone Stomach (Gastric) Tube 9

SUCTION TUBE SERIES 10

Silicone wound drainage system 11
Silicone C.W.V. Reservoir 12
Wound drainage trocar 13
Reservoir -Sterile 14
Silicone Round Drain 15
Silicone Flat Drain 16
Silicone Endo Drain 17
Silicone T Drainage Tube 18

INCONTINENCE MANAGEMENT SERIES 19

Stool Management System 20
Male External Catheter 21

URINARY CATHETER SERIES 22

Silicone Laryngeal MaskTube 23
Flexi-rib tubing 24
Silicone 2 way Foley balloon Catheter 25
Silicone 3 way Foley balloon Catheter 26
Link Connecting Tubing 27
Silicone Drainage Tube 28

SHENYUN

ABOUT

Shenyun Medical is proud to be one of the CN leading manufacturer of single use, sterile Ward & Theatre Consumables and Custom Procedure Packs. Since our incorporation in 2019, the business has grown year on year. We market our products and services in over 50 countries worldwide and employ around 120 people at our purpose-built premises in Suzhou.

In line with our ISO 13485 accreditation, Shenyun has a policy of continual improvement in order to meet the needs of the changing global standards for sterile, single use medical devices. Continual investment in people, training, and technology, has enabled us to provide an increasingly wide range of user friendly, high specification products. We also promote standards of safety, health, and welfare to provide a healthy and safe working environment.

Our core skills in manufacturing and engineering make us competitive through technological innovation, enabling us to be innovative, flexible and responsive, supplying healthcare organizations and businesses across the globe with the highest quality CN manufactured products.

Our vision will be delivered by supplying world class products and delivering distinctive customer service supported by a culture of continuous improvement and investing in our people.

Shenyun Medical is also proud to be one of the leading suppliers of polymer material consumables in the healthcare environment. As a hospital-focused company, we sell directly for healthcare professionals in various fields, including intensive care unit and operating room.

Want more
information?



Jack Liu



@shenyun_medical



@shenyun_medical



Suzhou Shenyun Medical Equipment Co., Ltd.

WEIGHT LOSS PRODUCT SERIES

Bariatric surgery products are safe, convenient and professional
Made from medical-grade silicone, Shenyun Medical® offers a full line of weight loss products,
gastric alignment tubes, gastric balloons, gastric bands and swallowable balloons
Different Bariatric Surgery Applications.

GASTRIC CALIBRATION TUBE



Shenyun Medical® Gastric calibration tube features:

- The Calibration TUBE is introduced orally until it reaches the positioning site. Once the gastric pouch has been completed, a leak test can be performed. For this purpose, a syringe is connected using the universal connector and air or liquid is introduced into the stomach segment. The tube can be closed as required using the tube closure clip. Following completion of the leak test, the liquid is aspirated via the holes in the gastric calibration tube.

I Type Gastric calibration tube

REF. No.	Size	Description
SY01-01	32 FR	
SY01-02	34 FR	Without balloon
SY01-03	36 FR	
SY01-04	38 FR	
SY01-05	40 FR	

SPECIFICATIONS

GASTRIC CALIBRATION TUBE

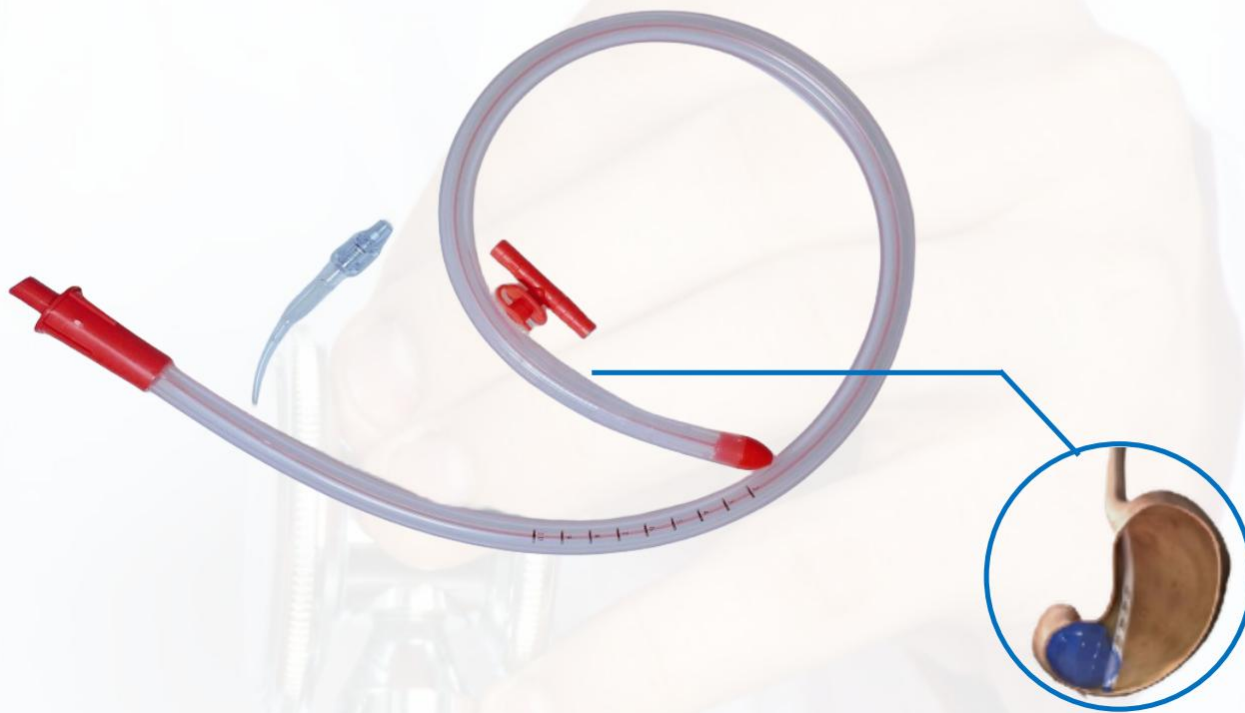

Shenyun Medical® Gastric calibration tube features:

- The Calibration TUBE is introduced orally until it reaches the positioning site. Once the gastric pouch has been completed, a leak test can be performed. For this purpose, a syringe is connected using the universal connector and air or liquid is introduced into the stomach segment. The tube can be closed as required using the tube closure clip. Following completion of the leak test, the liquid is aspirated via the holes in the gastric calibration tube.

II Type Gastric calibration tube

REF. No.	Size	Description
SY02-01	32 FR	
SY02-02	34 FR	With balloon
SY02-03	36 FR	
SY02-04	38 FR	
SY02-05	40 FR	

SPECIFICATIONS

Want more
information?



Jack Liu



@shenyun_medical



@shenyun_medical



Suzhou Shenyun Medical Equipment Co., Ltd.

GASTRIC BALLOON

Shenyun Medical®Gastric balloon **Features:**



Gastric balloon placement is a weight-loss procedure that involves placing a saline-filled silicone balloon in your stomach.

Like other weight-loss procedures, a Gastric balloon requires commitment to a healthier lifestyle. You need to make permanent healthy changes to your diet and get regular exercise to help ensure the long-term success of the procedure.

Product Code	Type	Length	Qty per Box
SY12	500ml	450mm	12

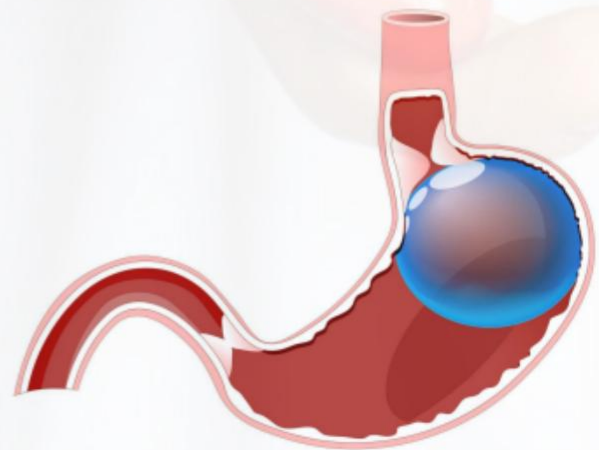

SILICONE STOMACH (GASTRIC) TUBE

Shenyun Medical®

Silicone Stomach (Gastric) Tube Features:

- Medical grade silicone for superior biocompatibility.
- Proper softness and excellent flexibility for enhanced patient comfort.
- Tapered tip for easy insertion.
- Depth marking for position confirmation.

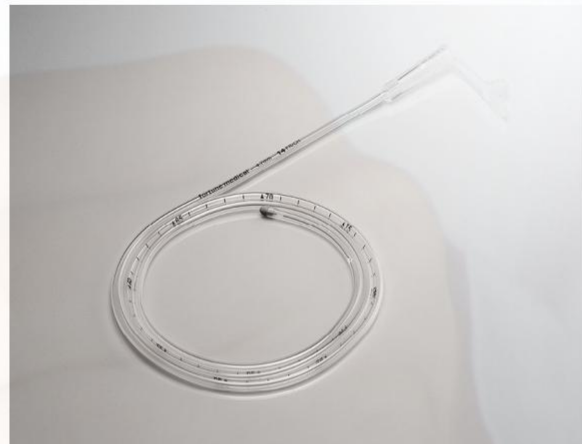

Silicone Stomach (Gastric) Tube is designed for nutrition supplement to stomach and may be recommended for various purposes: for patients who cannot take food or swallow, take enough food by mouth to keep nutrition, congenital defects of mouth, esophagus, or stomach.

SPECIFICATIONS

Stomach (Gastric) Tube:

REF. No.	Size	Length	Description	REF. No.	Size	Length	Description
SY12-01	4FR	400 mm	- Attached plug - Depth marking - X-ray opaque line	SY12-06	12 FR	1200 mm	- Attached plug - Depth marking - X-ray opaque line
SY12-02	5FR			SY12-07	14 FR		
SY12-03	6 FR			SY12-08	16 FR		
SY12-04	8 FR	800 mm		SY12-09	18 FR		
SY12-05	10 FR			SY12-10	20 FR		



Want more information?



Jack Liu



@shenyun_medical



@shenyun_medical



Suzhou Shenyun Medical Equipment Co., Ltd.



SUCTION TUBE SERIES

Suction tube series products are safe, convenient and professional
Shenyun Medical® is made of medical-grade silicone and provides a full
range of drainage products, wound drainage sets, suction tubes, silicone
tubes, and ear, nose and throat tubes.
Different drainage surgical applications.

Want more
information?



Jack Liu



@shenyun_medical



@shenyun_medical



Suzhou Shenyun Medical Equipment Co., Ltd.

SILICONE WOUND DRAINAGE SYSTEM

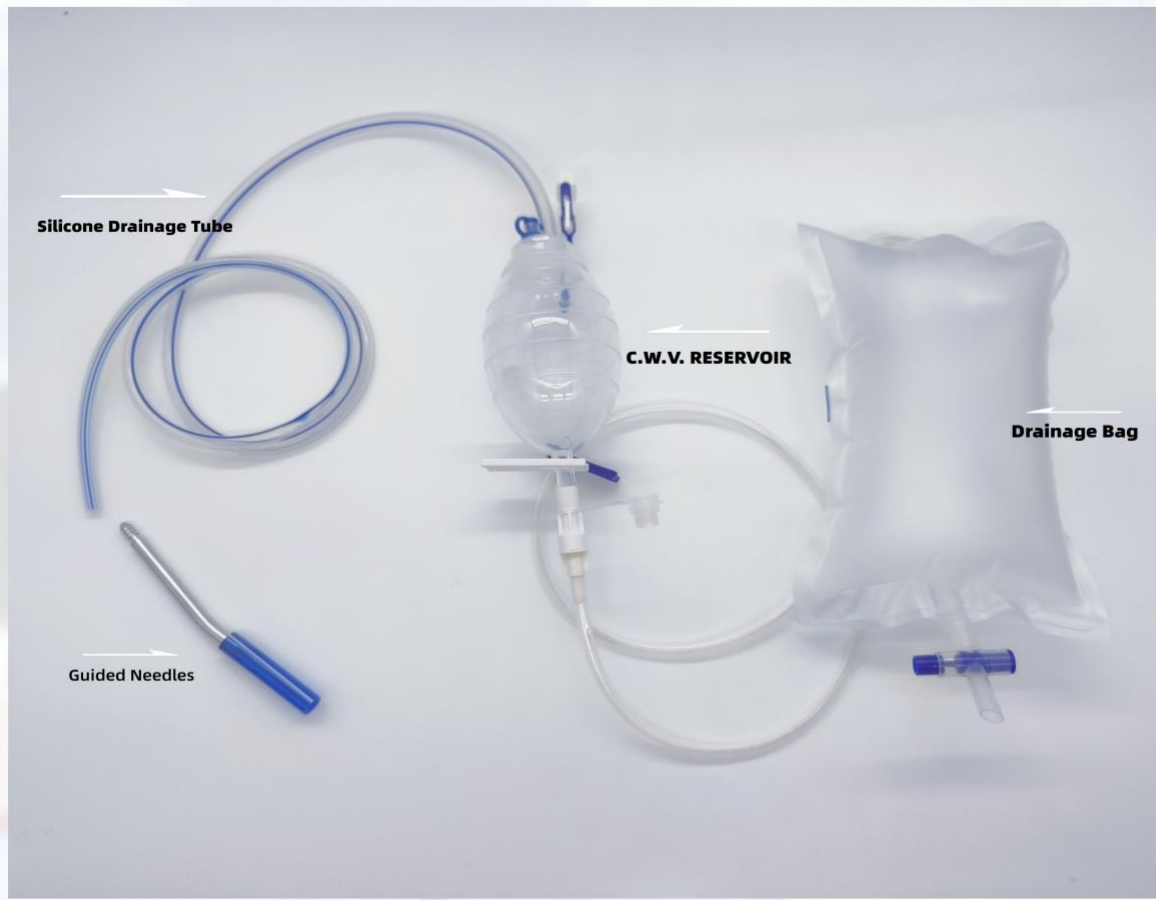

Postoperative wound drainage is safe and easy. Made from medical grade silicone, Shenyun Medical® offers a full line of C.W.V. (Closed Wound Vacuum) reservoirs, drains, trocars and collection bags for different surgical applications.

- I. Silicone C.W.V. Reservoir
- II. Collection Bag
- III. Trocar
- IV. Silicone Flat Drain
- V. Round Drain
- VI. Silicone Vac Drain
- VII. Silicone Endo Drain

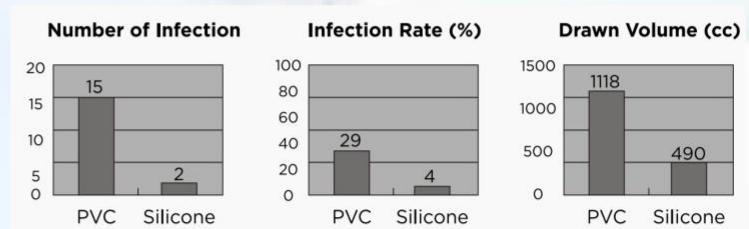

*Data based on 102 female patients who underwent surgery, 52 of whom used PVC wound drainage systems and 50 of whom used Shenyun Medical® silicone wound drainage systems. Drainage pull-out times, used to measure liquid withdrawal, were 6.18 days for PVC systems and 5.18 days for silicone systems.

SILICONE C.W.V. RESERVOIR



Shenyun Medical® Silicone C.W.V. Reservoir Features:

- Medical grade silicone for superior biocompatibility.
- Low pressure design provides continuous gentle suction and minimizes tissue trauma.
- Volume marking provides easy measurement.
- Flat bottom design for easy positioning.
- Non-reflex valve.
- Hanger and bedside clip for secured attachment.
- Available with 2 sizes, 2 outlet directions.
- Optional extra inlet is available on 100 & 200 cc models to connect second tube.
- Bottom outlet models are capable to connect with Collection Bag.
- Sterilized double package.

SPECIFICATIONS

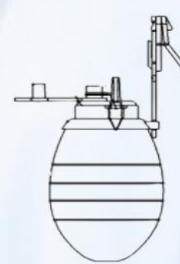

SY-06-01/02

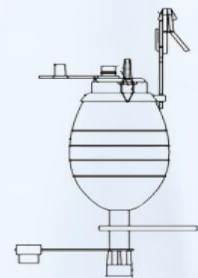

SY-06-03/04

Product Code	Type	Size	Qty per Box
SY-03-06-01	Top outlet	100cc	200
SY-03-06-02	Top outlet	200cc	100
SY-03-06-03	Bottom outlet	100cc	200
SY-03-06-04	Bottom outlet	200cc	100

Want more information?



Jack Liu



@shenyun_medical



@shenyun_medical



Suzhou Shenyun Medical Equipment Co., Ltd.

WOUND DRAINAGE TROCAR



Shenyun Medical® Wound Drainage Trocar features:

- Made of stainless steel.
- Sharp, smooth and burr free.
- Protection cover.
- Customized specification is available upon request.

SPECIFICATIONS

Trocar:

REF. No.	Size	Description
SY-03-08-01	8 FR	
SY-03-08-02	10 FR	
SY-03-08-03	16 FR	Stainless steel, with Protection cover
SY-03-08-04	19 FR	
SY-03-08-05	20 FR	
SY-03-08-06	21 FR	

Trocar:

REF. No.	Size	Description
SY-03-08-07	8 FR	
SY-03-08-08	10 FR	
SY-03-08-09	16 FR	Stainless steel, foldable, with Protection cover
SY-03-08-10	19 FR	
SY-03-08-11	20 FR	
SY-03-08-12	21 FR	



RESERVOIR -STERILE



Shenyun Medical® Reservoir -Sterile:

Shenyun Medical® Reservoir is available in either a 300 or 400ml size. All are packaged sterile in a pre-compressed state and are capable of dual drainage. A standard anti-reflux valve has also been incorporated to help prevent the reverse flow of wound exudates during emptying and reactivation. Markers are provided at increments along the side of the reservoir to facilitate the approximate measurement of fluid. A drain port with attached plug is provided as a method of emptying exudate collected by the unit.

SPECIFICATIONS

Product Code	Type	Size	Qty per Box
SY-03-09-01	Press version	300cc	100
SY-03-09-02	Press version	400cc	100

Want more
information?



Jack Liu



@shenyun_medical



@shenyun_medical



Suzhou Shenyun Medical Equipment Co., Ltd.

SILICONE ROUND DRAIN

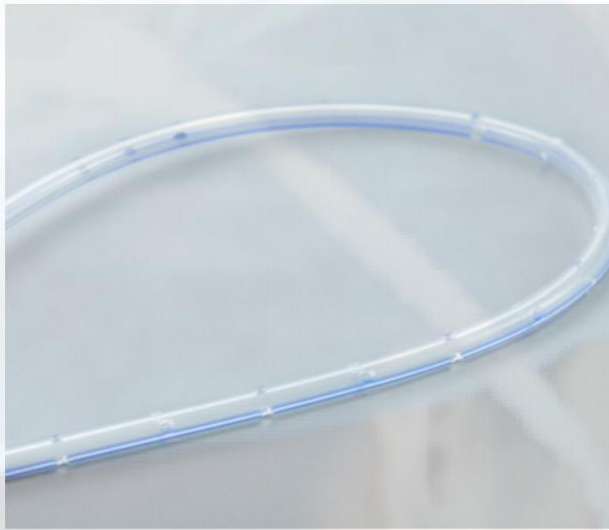

Shenyun Medical® Silicone Round Drain Features:

- Medical grade silicone for superior biocompatibility.
- Clear tubing for visual drainage inspection.
- X-ray opaque line.
- Rigid and flexible structure for kinking resistance.
- Clear tubing provides inspection and drainage

- A** Silicone Round Drain
- B** Silicone Round Drain Kit
- C** Silicone Round Drain Set*
- D** Silicone Round Drain System*
- E** Silicone Round Drain Bag System*

Round Drain:

REF. No.	Size	Description
SY03-01-01	8 FR	
SY03-01-02	10 FR	
SY03-01-03	12 FR	- Middle perforation
SY03-01-04	14 FR	- 1200 mm
SY03-01-05	16 FR	- X-ray opaque line
SY03-01-06	18 FR	
SY03-01-07	20 FR	
SY03-01-08	22 FR	



Round Drain Kit:

REF. No.	Size	Description
SY03-01-09	8 FR	8 FR end perf. Round, attached Trocar
SY03-01-10	10 FR	10 FR end perf. Round, attached Trocar
SY03-01-11	14 FR	14 FR end perf. Round, attached Trocar
SY03-01-12	16 FR	16 FR end perf. Round, attached Trocar
SY03-01-13	18 FR	18 FR end perf. Round, attached Trocar
SY03-01-14	20 FR	20 FR end perf. Round, attached Trocar
SY03-01-15	22 FR	22 FR end perf. Round, attached Trocar

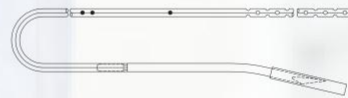

Round Drain Bag System*:

REF. No.	Size	Description
SY03-01-16	8 FR	8 FR end perf. Round, Trocar, 100 cc Reservoir, 200 cc Bag
SY03-01-17	10 FR	10 FR end perf. Round, Trocar, 100 cc Reservoir, 200 cc Bag
SY03-01-18	14 FR	14 FR end perf. Round, Trocar, 100 cc Reservoir, 200 cc Bag
SY03-01-19	16 FR	16 FR end perf. Round, Trocar, 100 cc Reservoir, 200 cc Bag
SY03-01-20	18 FR	18 FR end perf. Round, Trocar, 100 cc Reservoir, 200 cc Bag
SY03-01-21	20 FR	20 FR end perf. Round, Trocar, 100 cc Reservoir, 200 cc Bag
SY03-01-22	22 FR	22 FR end perf. Round, Trocar, 100 cc Reservoir, 200 cc Bag

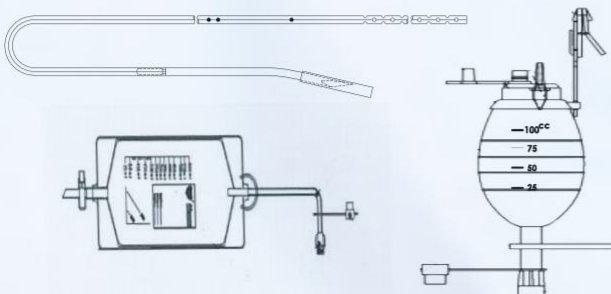

Round Drain System*:

REF. No.	Size	Description
SY03-01-23	8 FR	8 FR end perf. Round, Trocar, 100 cc Reservoir
SY03-01-24	10 FR	10 FR end perf. Round, Trocar, 100 cc Reservoir
SY03-01-25	14 FR	14 FR end perf. Round, Trocar, 100 cc Reservoir
SY03-01-26	16 FR	16 FR end perf. Round, Trocar, 100 cc Reservoir
SY03-01-27	18 FR	18 FR end perf. Round, Trocar, 100 cc Reservoir
SY03-01-28	20 FR	20 FR end perf. Round, Trocar, 100 cc Reservoir
SY03-01-29	22 FR	22 FR mid. perf. Round, Trocar, 100 cc Reservoir

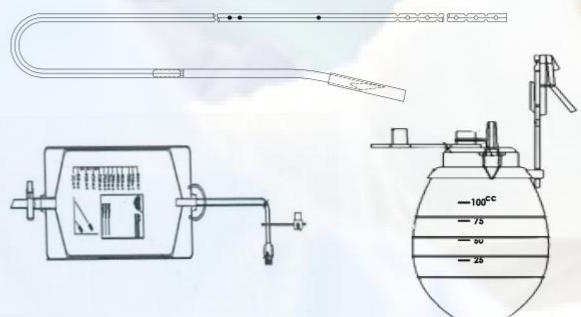

SILICONE FLAT DRAIN

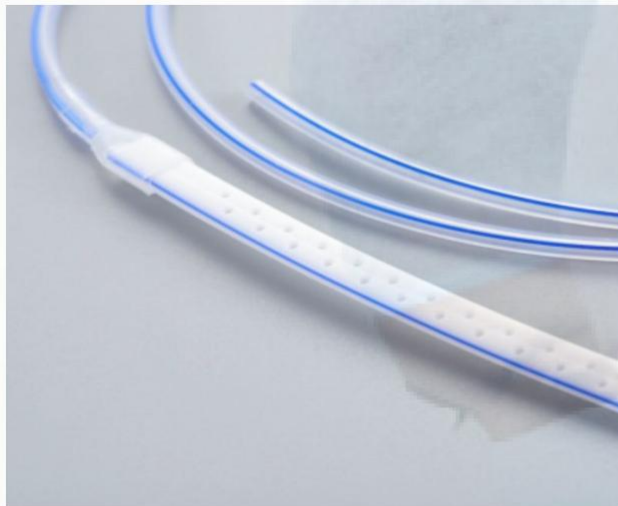

Shenyun Medical® Silicone Flat Drain Features:

- Medical grade silicone for superior biocompatibility.
- X-ray opaque effectiveness.
- Soft yet kink-resistant structure to minimize clog or obstruct.
- Clear connecting tube provides inspection and Drainage visibility.
- Available with 4 sizes, 2 perforations types.
- Sterilized double package.
- Available with pre-connected Trocar: Silicone Flat Drain Kit.

- A** Silicone Flat Drain
- B** Silicone Flat Drain Kit
- C** Silicone Flat Drain Set*
- D** Silicone Flat Drain System*
- E** Silicone Flat Drain Bag System*

Trocar: Silicone Flat Drain

REF. No.	Size	Description
SY03-03-01	7 x 3 mm	3/4 perforation on 200 mm drain
SY03-03-02	10 x 4 mm	X-ray opaque effective



Trocar: Silicone Flat Drain Kit

REF. No.	Size	Description
SY03-03-03	7 x 3 mm	3/4 perforation on 200 mm drain
SY03-03-04	10 x 4 mm	X-ray opaque effective

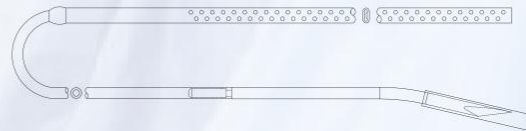

Flat Drain Bag System:

REF. No.	Size	Description
SY03-03-07	3 x 7 mm	7 mm 3/4 Flat Drain, Trocar, 100 cc Reservoir, 500 cc Bag
SY03-03-08	4 x 10 mm	10 mm 3/4 Flat Drain, Trocar, 100 cc Reservoir, 500 cc Bag

* Flat Drain Set, Flat Drain System and Flat Drain Bag System are also available with 200 cc.

* Flat Drain Bag System is also available with 500 cc or 1000 cc Collection Bag.

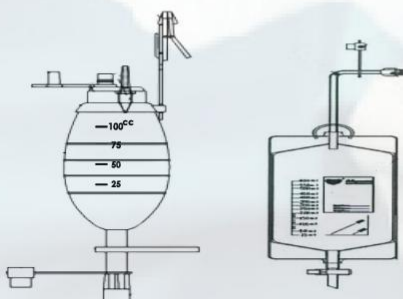
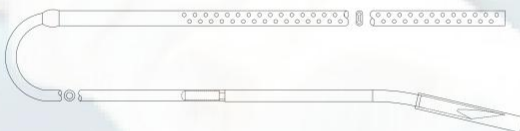

Flat Drain Set*:

REF. No.	Size	Description
SY03-03-05	7 x 3 mm	7 mm 3/4 Flat Drain, 100 cc Reservoir
SY03-03-06	10 x 4 mm	10 mm 3/4 Flat Drain, 100 cc Reservoir

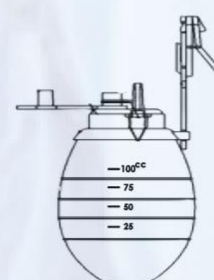

Want more information?



Jack Liu



@shenyun_medical



@shenyun_medical



Suzhou Shenyun Medical Equipment Co., Ltd.

SILICONE ENDO DRAIN

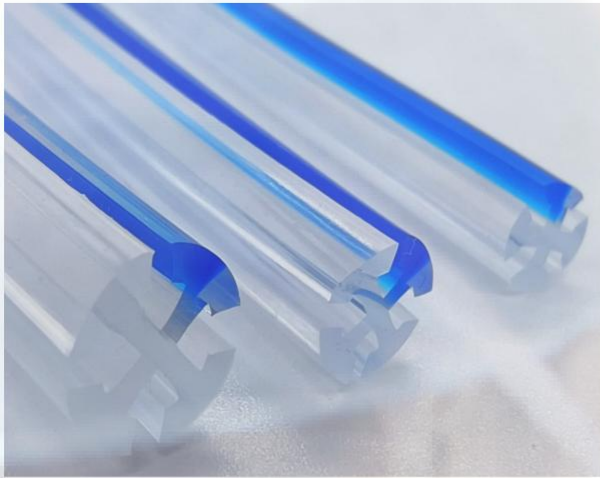

Shenyun Medical® Silicone Endo Drain Features:

- Medical grade silicone for superior biocompatibility.
- X-ray opaque effectiveness.
- Multiple narrow ducts structure instead of perforation.
- Reduce withdrawal difficulty against tissue ingrowth.
- Rigid structure offers excellent kink-resistant
- Sterilized double package.
- Available with pre-connected Trocar: Vac Drain Kit.

- A** Endo Drain
- B** Endo Drain Kit
- C** Endo Drain Set*
- D** Endo Drain System*

Endo Drain:

REF. No.	Size	Description
SY03-02-01	10 FR	
SY03-02-02	15 FR	- Transparent
SY03-02-03	19 FR	- 1200 mm
SY03-02-04	21 FR	- X-ray opaque line
SY03-02-05	24 FR	
SY03-02-06	26 FR	



Endo Drain Kit:

REF. No.	Size	Description
SY03-02-07	10 FR	10 FR Endo, attached Trocar
SY03-02-08	15 FR	15 FR Endo, attached Trocar
SY03-02-09	19 FR	19 FR Endo, attached Trocar
SY03-02-10	21 FR	21 FR Endo, attached Trocar

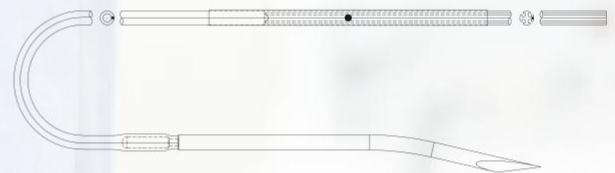

Drain Bag System*:

REF. No.	Size	Description
SY03-02-11	10 FR	10 FR Endo, Trocar, 100 cc Reservoir, 200 cc Bag
SY03-02-12	15 FR	15 FR Endo, Trocar, 100 cc Reservoir, 200 cc Bag
SY03-02-13	19 FR	19 FR Endo, Trocar, 100 cc Reservoir, 200 cc Bag
SY03-02-14	21 FR	21 FR Endo, Trocar, 100 cc Reservoir, 200 cc Bag

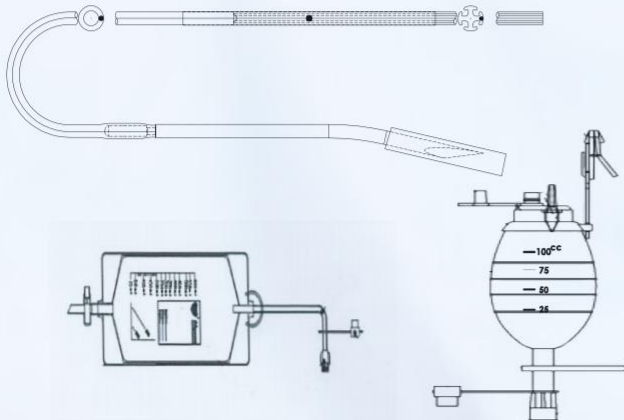

Endo Drain Set*:

REF. No.	Size	Description
SY03-02-15	10 FR	10 FR Endo, 100 cc Reservoir
SY03-02-16	15 FR	15 FR Endo, 100 cc Reservoir
SY03-02-17	19 FR	19 FR Endo, 100 cc Reservoir
SY03-02-18	21 FR	21 FR Endo, 100 cc Reservoir

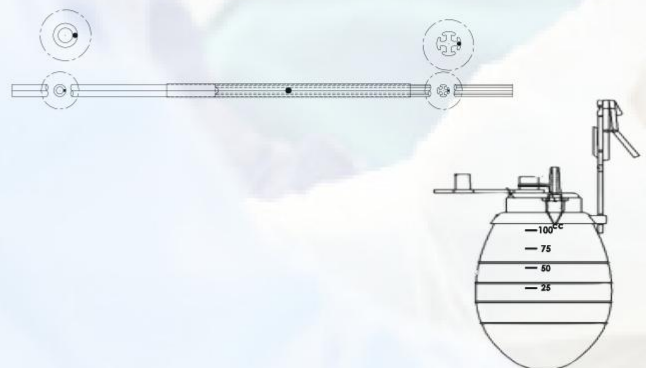

SILICONE T DRAINAGE TUBE



Shenyun Medical® Silicone T Drainage Tube Feature:

- Medical grade silicone for superior biocompatibility.
- Proper rigidity design to prevent from kink or clog over time.
- Larger diameter of connecting tube allows smooth withdrawn.
- X-ray opaque line.
- Sterilized double packaging.

A T Drainage Tube:

B T Drainage Set

T Drainage Tube:

REF. No.	Size	Description
SY03-04-01	15 FR	-A: 180 mm -B: 450 mm
SY03-04-02	19 FR	-X-ray opaque line -w/large bore male connector

Endo Drain Kit:

REF. No.	Size	Description
SY03-04-03	15 FR	15 FR Endo, Trocar, 100 cc Reservoir, 200 cc Bag
SY03-04-04	19 FR	19 FR Endo, Trocar, 100 cc Reservoir, 200 cc Bag

Want more information?



Jack Liu



@shenyun_medical



@shenyun_medical



Suzhou Shenyun Medical Equipment Co., Ltd.

INCONTINENCE MANAGEMENT SERIES

Incontinence management series products are safe, convenient and professional. Shenyun Medical® is made of medical-grade silicone and provides a full range of incontinence products: Stool management system, catheterization management system.

Different clinical incontinence, ICU and daily care applications.

Want more
information?



Jack Liu



@shenyun_medical



@shenyun_medical



Suzhou Shenyun Medical Equipment Co., Ltd.

STOOL MANAGEMENT SYSTEM



PROTECTING SKIN INTEGRITY is essential to patient health.

Shenyun Medical® The Advance Stool Management System's (SMS) design draws from clinician insight to help mitigate damage to delicate tissue due to leakage, pressure and friction.

- Reduce the risk of skin breakdown by helping to keep the skin clean, dry and free from contaminants. disposable, closed system.
- Help to protect wounds, surgical sites, and burns from contamination by stool.
- Help improve patient comfort.
- Help reduce the cost of managing fecal incontinence.
- Help maintain patient dignity.



MINIMIZED PRESSURE

Studies suggest that high pressure designs may impact capillary blood flow and cause mucosal tissue trauma.^{1,2,3,4}

In simulated bench tests the Shenyun Medical® Advance SMS offers an average of 69% less resting pressure* than other commercially available fecal management devices.* **In a randomized clinical study, retention cuff pressure was at least 2-fold lower for DIGNISHIELD™ ADVANCE SMS than for the other devices.¹**

*bench data on file, may not correlate to clinical use

In-Vivo Resting Cuff Pressure vs. Fill Volume¹

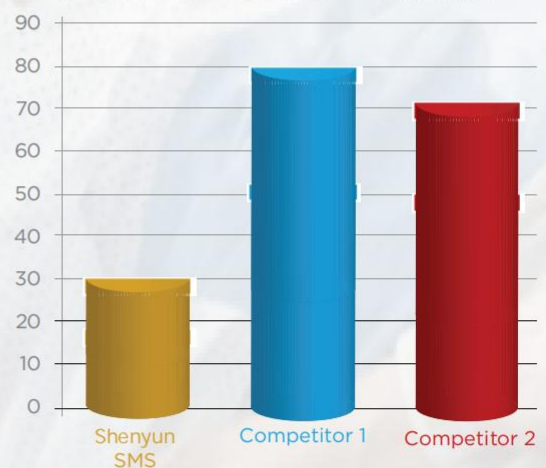

Average retention cuff pressure for subjects in three different positions and at three different elevation angles.

Product Code	Type	Case Quantity	Qty per Box
SY06-01	SMS002	1	50
SY06-02	SMS2B1L	3	30

MALE EXTERNAL CATHETER

Shenyun Medical® Male External Catheter:



- Use the correct size, look at the model number on the label
- Place the correct sizing guide below the widest diameter of the penile shaft (not the glans).
- In cases of shorter shaft length, select the Short style catheter for better adhesion. When a larger adhesive
- Band is needed to improve adhesion, select the Extended version catheter
- Trim pubic hair if necessary
- Wash penis with mild soap and warm water. Dry thoroughly.

The male external catheter, self-adhering and engineered with a clear, silicone* material, is available in three styles: Standard, Special, and Extra. External catheters provide a good alternative to indwelling catheters, diapers or other absorbent products .



Model 1: Standard model

REF. No.	Size	Description
SY08-01	18 MM	
SY08-02	20 MM	
SY08-03	25 MM	
SY08-04	29 MM	
SY08-05	32 MM	
SY08-06	36 MM	
SY08-07	41 MM	

Model 2: Short style

REF. No.	Size	Description
SY08-08	18 MM	
SY08-09	20 MM	
SY08-10	25 MM	
SY08-11	29 MM	
SY08-12	32 MM	
SY08-13	36 MM	
SY08-14	41 MM	

Model 3: Extended version

REF. No.	Size	Description
SY08-15	18 MM	
SY08-16	20MM	
SY08-17	25 MM	
SY08-18	29 MM	
SY08-19	32 MM	
SY08-20	36 MM	
SY08-21	41 MM	

Want more information?



Jack Liu



@shenyun_medical



@shenyun_medical



Suzhou Shenyun Medical Equipment Co., Ltd.

URINARY CATHETER SERIES

Urinary catheter series products are safe, convenient and professional. Shenyun Medical® is made of medical-grade silicone and provides a full range of urology products: catheters, catheter covers, and catheter management systems. Different urological surgical applications.

SILICONE LARYNGEAL MASK TUBE

Shenyun Medical®

Silicone Laryngeal Mask Tube (LMT-Standard) Features:



- Medical grade silicone for superior biocompatibility.
- Disposable.
- X-ray opaque line works both for confirmation of intubated tube.
- X-ray opaque line also works as a reference line for insertion angle.
- Ribbed structure throughout the internal lumen to minimize friction.
- Soft and low friction cuff reduces intubation difficulty and provides excellent sealing and patient comfort.
- Non-epiglottis-bar design provides easy and clear access through the lumen.
- Smooth yet firm back plate of the cuff facilitates insertion.
- Unique embedded inflation line merged into the tube, which lessens extra care handling during insertion and avoids accident damage by teeth or on-site instrument.

Silicone Laryngeal Mask Tube, LMT-Standard:

REF. No.	Size	Patient Weight	Maximum Inflation Volume	Description
SY10-01	1.0	Neonate < 5kg	4 ml	
SY10-02	1.5	Infant 5-10 kg	7 ml	
SY10-03	2.0	Infant 10-20 kg	10 ml	- Disposable silicone laryngeal mask
SY10-04	2.5	Child 20-30 kg	14 ml	- Polysulfone connector
SY10-05	3.0	Child 30-50 kg	20 ml	- X-ray opaque line
SY10-06	4.0	Adult 50-70 kg	30 ml	- Vent port
SY10-07	5.0	Adult 70-100 kg	40 ml	
SY10-08	6.0	Adult >100 kg	50 ml	

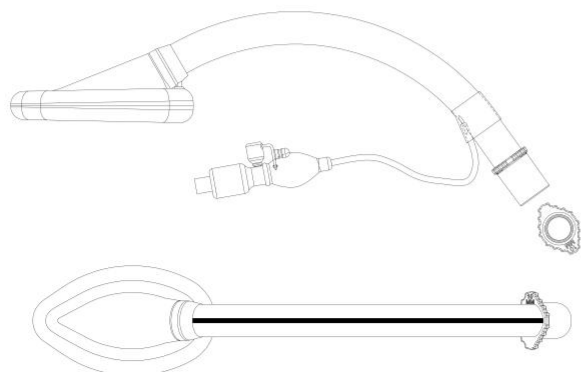
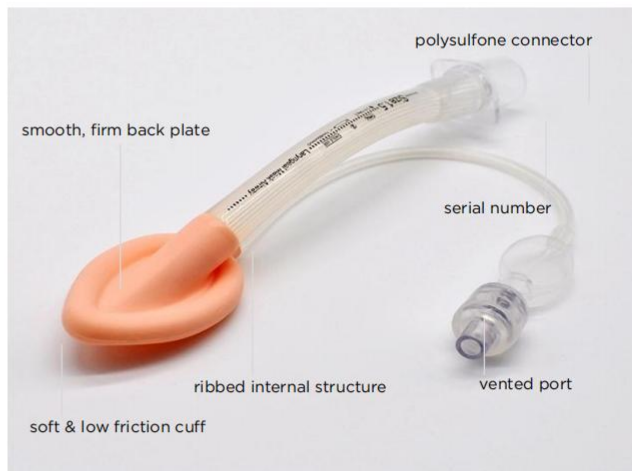

FLEXI-RIB TUBING

Shenyun Medical®

Flexi-rib tubing Features:



Our Flexi-Rib Tubing is used to connect suction sources to suction waste collection systems, suction catheters, yankauers, suction probes and other suction devices.

- Ribbed connecting tubing for enhanced drapability
- Resistant to kinking
- Economical box size
- Colour coded funnel connector to denote tube size
- Sterile double wrapped individual peel pouches

Product Code	Type	Length	Inside Diam. mm	Qty per Box
SY09-02-01	F/F	2.0m	6	60
SY09-02-02	F/F	3.0m	6	50
SY09-02-03	F/F	3.5m	6	50
SY09-02-04	F/F/M	2.0m	6	60
SY09-02-05	F/F/M	3.0m	6	50
SY09-02-06	F/F	2.0m	7	60
SY09-02-07	F/F	3.0m	7	50
SY09-02-08	F/F	3.5m	7	40
SY09-02-09	F/F/M	3.0m	7	50
SY09-02-10	F/F/M	3.5m	7	40
SY09-02-11	F/F/M/VC	1.8m	7	25
SY09-02-12	F/F/M/VC	2.5m	7	20

Want more information?



Jack Liu



@shenyun_medical



@shenyun_medical



Suzhou Shenyun Medical Equipment Co., Ltd.

SILICONE FOLEY BALLOON CATHETER

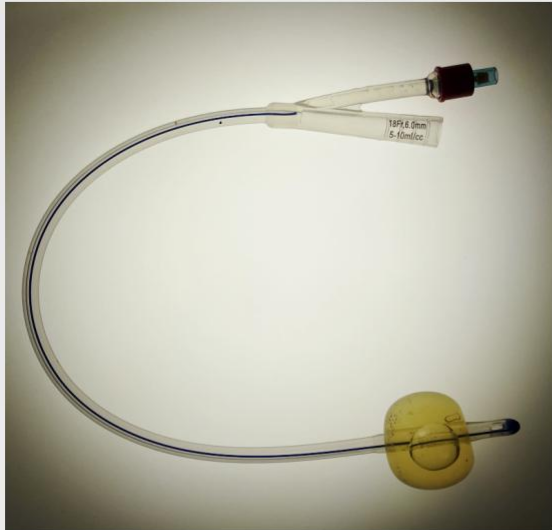

Shenyun Medical® Silicone 2 way Foley balloon Catheter Features:

- Medical grade silicone for superior biocompatibility.
- Transparent medical grade silicone tube allows easy visual inspection and fluid observation.
- X-ray opaque line allows for confirmation of intubated tube using X-ray.
- Soft and uniformly inflated balloon makes the tube sit well against the bladder.
- Smooth round shaft can minimize trauma during insertion and withdrawal.
- 6FR, 8FR and 10FR Pediatric Foley Catheter has disposable stylet for easy insertion.
- Sterilized double packaging.
- Firm yet flexible tip designed to aid insertion.

- A** Pediatric
- B** Standard, 5-10 cc/ml
- C** Standard, 20-30 cc/ml
- D** Female
- E** Tiemann Tip

SPECIFICATIONS

2-Way Foley Balloon Catheter, Pediatric:

REF. No.	Size	Balloon	Length	Description
SY07-01	6 FR	1-1.5 cc/ml	330 mm	- Stylet
SY07-02	8 FR	2-3 cc/ml		- X-ray opaque line
SY07-03	10 FR	3-5 cc/ml		

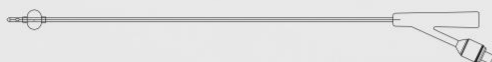

2-Way Foley Balloon Catheter, Standard, 20-30 cc/ml:

REF. No.	Size	Balloon	Length	Description
SY07-04	14 FR			
SY07-05	16 FR			
SY07-06	18 FR			
SY07-08	20 FR	20-30 cc/ml	420 mm	- X-ray opaque line
SY07-09	22 FR			
SY07-10	24 FR			
SY07-11	26 FR			

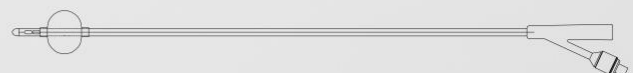

SILICONE FOLEY BALLOON CATHETER

Shenyun Medical®

Silicone 3 way Foley balloon Catheter

Features:

- Medical grade silicone for superior biocompatibility.
- Transparent tube with X-ray opaque line.
- A soft and uniformly inflated balloon makes the tube sit well against the bladder.
- 3-Way design with an attached plug on the irrigation funnel.
- Tapered Central funnel could be connected with irrigation bags.
- Sterilized double packaging.
- The tip of 3-way Foley Balloon Catheter with open hole, it could be used together with guide wire for difficulty in catheterization.

A Silicone 3-Way Foley Balloon

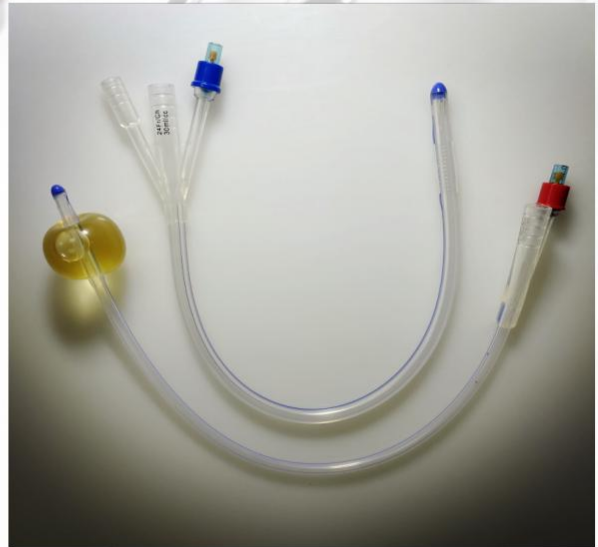

SPECIFICATIONS

3-Way Foley Balloon Catheter

REF. No.	Size	Balloon	Length	Description
SY07-12	14 FR			
SY07-13	16 FR			
SY07-14	18 FR			- Attached plug on flushing port
SY07-15	20 FR	20-30 cc/ml	420 mm	- X-ray opaque line
SY07-16	22 FR			
SY07-17	24 FR			
SY07-18	26 FR			



Want more information?



Jack Liu



@shenyun_medical



@shenyun_medical



Suzhou Shenyun Medical Equipment Co., Ltd.

LINK CONNECTING TUBING (BUBBLE TUBING)

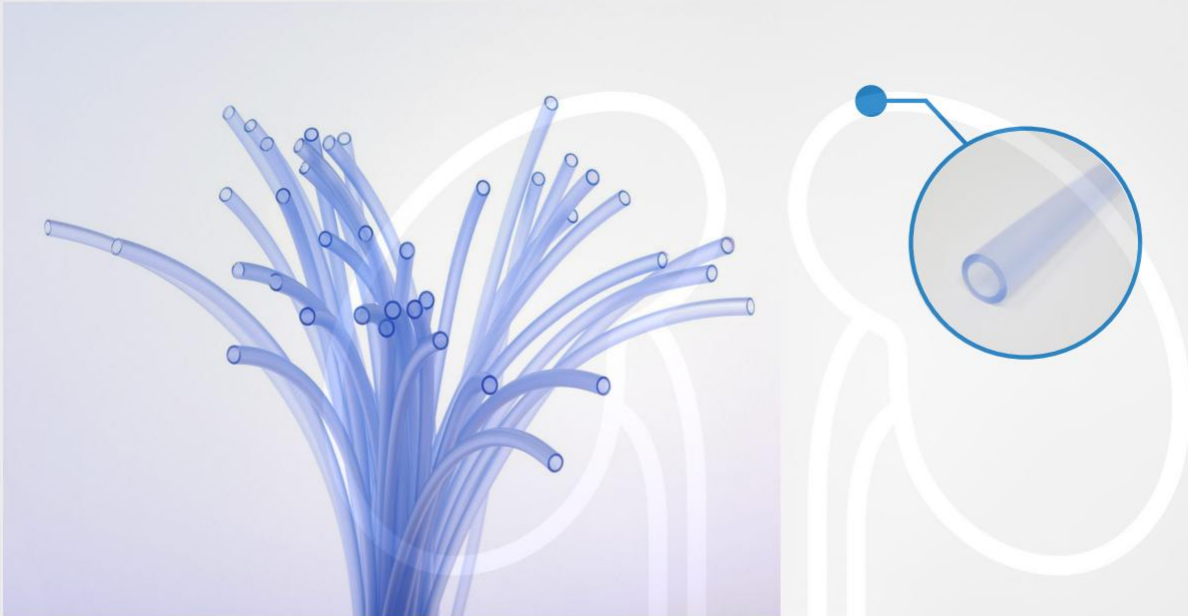

Link Connecting Tubing (Bubble Tubing) is available non-sterile and in 30 and 50 metre lengths, three diameters: 5mm, 6mm and 7mm supplied in convenient dispenser bags. Tube extruded with a bubble at approximately 1m intervals. Simply cut through the bubble at the required length to create either a male or female end to fit a range of suction devices.

SILICONE TUBE

Silicone Drainage Tube can be used in various applications: drainage, catheterization, air circulation, fluid circulation, injection, blood transfusion, I.V. injection, and treatment of blood circulation.

The tube is made of medical grade silicone with characteristics of long shelf life, low stimulation, non-toxic, tasteless and odorless. Besides, the strong silicone-oxygen chemical structure of silicone provides other particular properties:

Temperature Resistance

Silicone material withstands a wide range of temperature from -150°F to +600°F (-101°C to +260°C), and could be sterilized by many methods including ethylene oxide (ETO), Gamma radiation, E-beam, steam autoclaving.

Biocompatibility

Silicone material has superior biocompatibility with human tissue and body fluids. It could minimize adhesion and occlusion of medical solutions, body fluids, blood clots and tissue debris.

Mechanical Properties

Silicone material delivers excellent tear and tensile strength, great elongation, flexibility and durometer range from 45 to 65 Shore A.

Electrical Properties

Silicone material is non-conductive with good insulating properties and flexibility in electronic applications.

Chemical Resistance

Silicone material resist to water, Embolism, Fat, blood, Urine, Medical Solution and many chemicals including some acids, oxidizing chemicals, and isopropyl alcohol. Concentrated alkalines, and solvents should not be used with silicones.



Drainage Tube:

w/o X-ray				
REF. No.	I.D.	O.D.	Durometer	Description
SY04-01	2.5 mm	4.0 mm		
SY04-02	4.0 mm	5.5 mm	45 ± 5 Shore A	- S Type
SY04-03	5.0 mm	7.0 mm		- Single lumen
SY04-04	6.0 mm	8.0 mm		- 30 M/roll
SY04-05	7.0 mm	9.5 mm		
SY04-06	-	0.5 mm	1.0 mm	- H Type
SY04-07	-	1.0 mm	1.5 mm	65 ± 5 Shore A
SY04-08	-	1.0 mm	2.0 mm	- Single lumen
SY04-09		2.0 mm	3.0 mm	- 10 M/rol
SY04-10	2.5 mm	4.0 mm		
SY04-11	4.0 mm	5.5 mm		
SY04-12	5.0 mm	7.0 mm		
SY04-13	6.0 mm	8.0 mm	65 ± 5 Shore A	H Type
SY04-14	7.0 mm	9.5 mm		Single lumen
SY04-15	8.0 mm	11.0 mm		30 M/roll
SY04-16	9.0 mm	12.0 mm		
SY04-17	10.0 mm	14.0 mm		

*Custom sizes, shape, multiple lumens, x-ray opaque line, and colors are available upon request.

Shenyun Medical 2024

SHENYUN

Suzhou Shenyun Medical Equipment Co., Ltd.
No. 666, Yinzang Road, Linhu Town,, Suzhou City 215104, China
www.shenyunmedical.com



Jack Liu



@shenyun_medical



@shenyun_medical



Suzhou Shenyun Medical Equipment Co., Ltd.

